

Hubschrauber
Helicopter
Hélicoptère
Verbindingshelicopter
Helicóptero
Elicottero

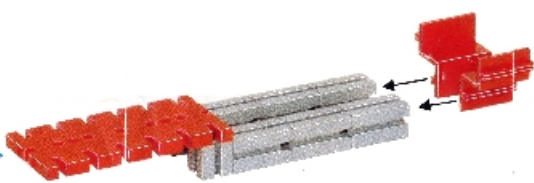

1**3****4****2****5**

6

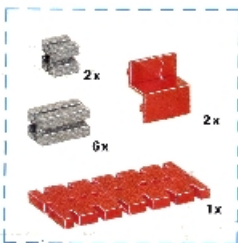
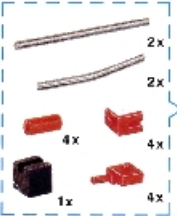
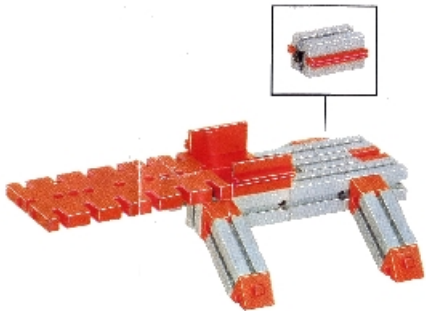
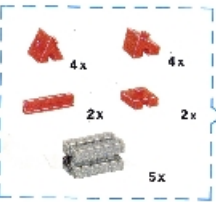
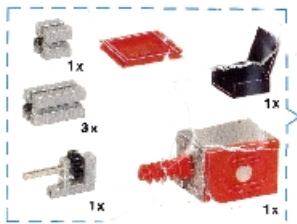
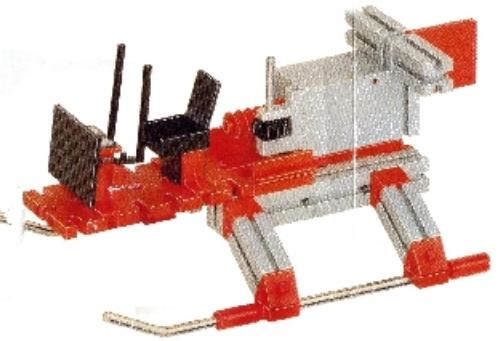
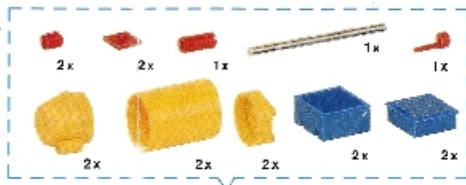

Download von
www.ft-fanarchiv.de

7

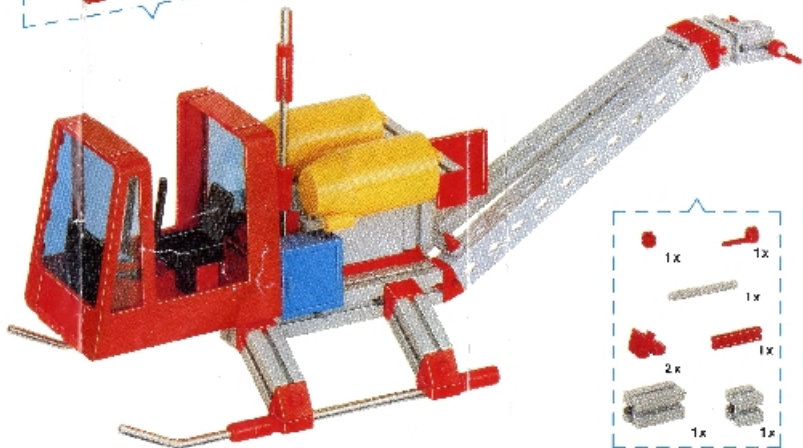
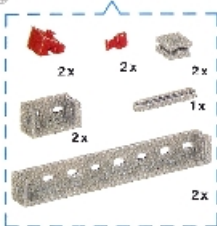
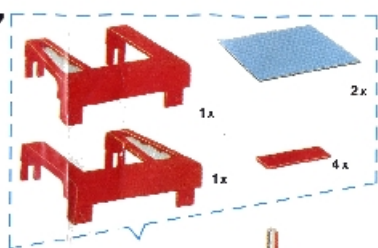

8

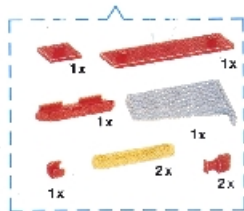
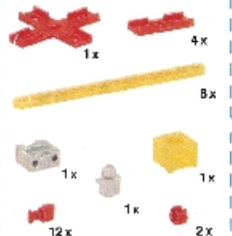
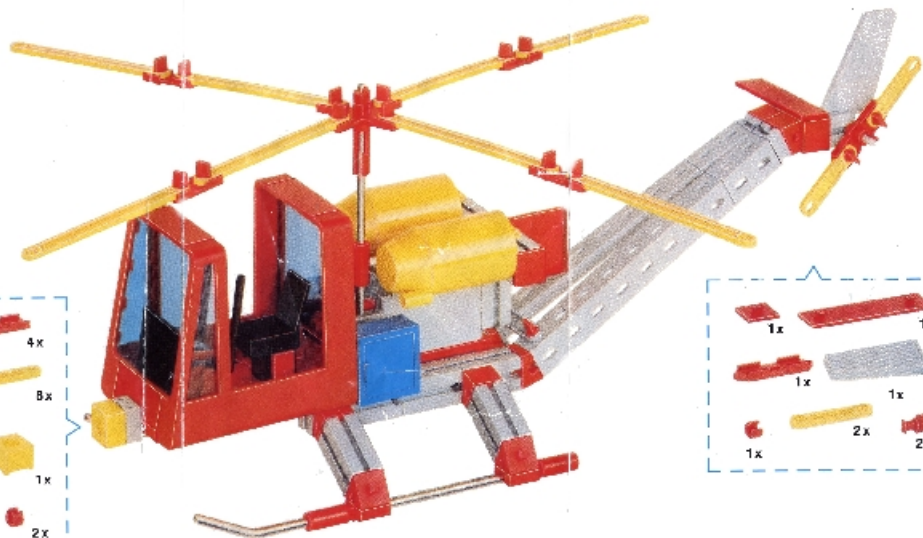

Motorisierbar mit Zusatzprojektion mini-mot. 1 oder mini-mot. 10 und mini-mot. 11.

Can be motorized using sets mini-mot. 1 or mini-mot. 10 and mini-mot. 11.

Motorisable par les boîtes complémentaires mini-mot. 1 ou mini-mot. 10 et mini-mot. 11.

Motorisierbar mit Erweiterungsboxen mini-mot. 1 of mini-mot. 10 oder mini-mot. 11.

Puede motorizarse en motor utilizando los engrases suplementarios mini-mot. 1 o mini-mot. 10 y mini-mot. 11.

Motorizable con accesorio mini-mot. 1 o mini-mot. 10 o mini-mot. 11.

